

LED LIGHTING EMERGENCY EQUIPMENT INSTRUCTION MANUAL

EM-L&EM-S series

IMPORTANT SAFEGUARDS

When using electrical equipment, basic safety precautions should always be followed, including the followings:

READ AND FOLLOW ALL SAFETY INSTRUCTIONS

1. CAUTION-To avoid electrical shock, do not mate unit connector until installation is complete and A.C. power is supplied to the unit.
2. CAUTION-This fixture provides more than one power supply output source. To reduce the risk of electrical shock, disconnect both normal and emergency sources by turning off the A.C. branch circuit and by disconnecting the unit connector.
3. CAUTION-This is a sealed unit. Components are not replaceable. Replace the entire unit when necessary.
4. CAUTION-Installation and servicing should be performed by qualified personnel only. Please disconnect before opening.
5. Do not use outdoor.
For use with grounded, UL Listed, damp location rated, indoor fixtures and case should be grounding.
The drivers are intended for ordinary locations and for permanent installation into one or more listed emergency luminaires.
This equipment has not been investigated for use in an air-handling fixture.
Do not for use in heated air outlets or hazardous locations
6. The EM-L/S series requires an unswitched A.C. power source of 100-277 volts. Properly cap the unused A.C. lead.
7. Do not mount near gas or electric heaters.
8. The EM-L/S series will supply 54VDC output at the individual rated specification for 90 minutes. See individual units for output specifications.
9. When the red indicator flashes or off, the emergency power supply is abnormal.
10. For use in 0 °C minimum, 50 °C maximum ambient temperatures.
11. The use of accessory equipment not recommended by the manufacturer may cause an unsafe condition.
12. Install in accordance with the National Electrical Code and local regulations.
13. Lighting fixture manufacturers, electricians, and end users need to ensure product system compatibility before final installation.
14. Equipment and test switch should be mounted in locations and at heights where it will not readily be subjected to tampering by unauthorized personnel. Indicator light should be mounted where can be seen.
15. **Equipment only use for LED lighting emergency backup. Do not use this equipment for other than its intended use.**
16. The weight of the equipment should be considered before installation, and the weight of each model is shown in FORM 1.
17. **The equipment must be used for normal use of the matching luminaires.**
DLC website: <https://www.designlights.org/search>
Energy star fixture website: <https://www.energystar.gov/productfinder/product/certified-light-fixtures/results>
18. CAUTION-This emergency battery pack for use LED fixture. Suitable voltage of LED module is EM-L/S2554-XX 18-54V, EM-L/S1654-XX and EM-L/S0854-XX 15-54V. This emergency battery pack suitable for fixture power higher than or equal to rating of emergency battery pack.

Other luminaire maximum mounting height can be found as follows:

1. Log onto the DesignLights Consortium website (www.designlights.org).
2. Click on **Search the DLC Qualified Product List?** button on the DLC homepage.
3. In the search by keyword, text window enter: luminaire manufacturer name and model name.
4. Click on **Search?** tab to open the **?Qualified Products List?**
5. Determine per **Reported Date?** efficacy shown in lumens per watt(lm/W)

Multiply lumens per watt by emergency driver rated output.

Refer to table below for the wattage of the specific model to be used in the luminaires.

Models	Output power (Constant)
EM-L0854-XX, EM-S0854-XX	8Watts
EM-L1654-XX, EM-S1654-XX	16Watts
EM-L2554-XX, EM-S2554-XX	25Watts

For example: Model EM-L0854-XX, (lm/W) x 8W = Minimum emergency lumens of fixture.

SAVE THESE INSTRUCTIONS



This product contains a rechargeable lithium-ion battery.

THE BATTERY MUST BE RECYCLED OR DISPOSED OF PROPERLY TO PREVENT FIRE.

INSTALLATION INSTRUCTION

CAUTION: Before installing, make sure the A.C. power is off and the EM-L/S series unit connector is disconnected.

1. For the EM-L series mounting method

Mounting method 1: Emergency backup outside lighting with flexible conduct.

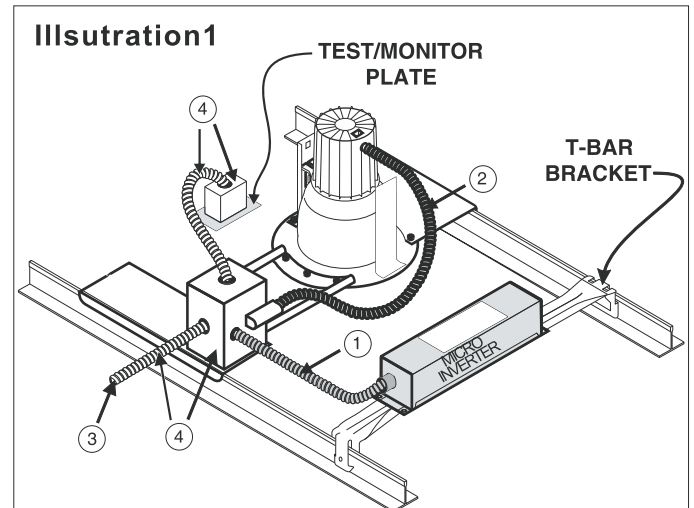

The T-BAR mounting bracket assembly is sold separately and is available from the factory as an accessory kit (T-BAR-MB). Call your local distributor or the factory for complete information.

- ①-Flexible conduit (supplied) to connect AC driver wires.
- ②-Existing conduit to run existing wires to lamp holder.
- ③-AC line in.
- ④-Conduit and junction box (not supplied).

Mounting method 2: Emergency backup inside lighting without flexible conduct.

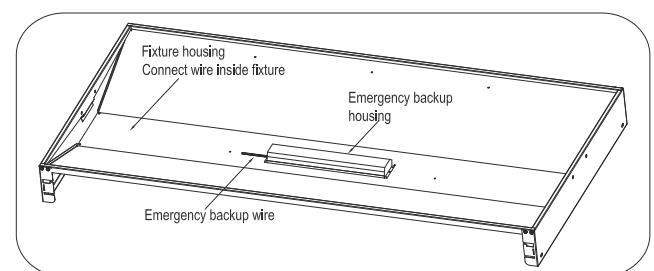

Mounting method 3: Emergency backup outside lighting without flexible conduit.

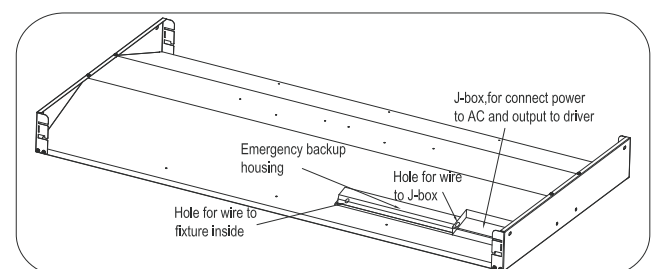

2. For the EM-S series mounting method

Emergency backup inside lighting, fix the emergency backup housing to fixture inside, fix the battery to fixture inside, connect emergency backup wire.

LED LIGHTING EMERGENCY EQUIPMENT INSTRUCTION MANUAL

EM-L&EM-S series

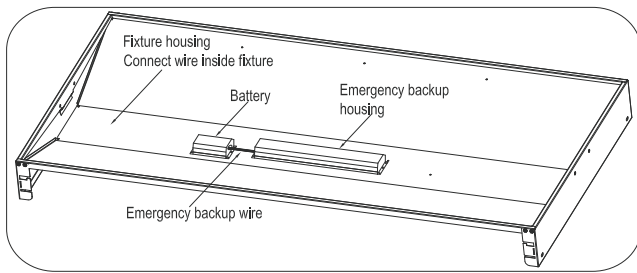

INSTALLING THE EMERGENCY EQUIPMENT NOTE:

- >The EM-L/S series will be located between the AC power sources and the AC driver as shown in wiring diagram section of instructions.
- >The EM-L/S series may be installed in close proximity to the fixture or remote from the fixture.
- >The maximum remote distance using 16AWG wire is 50ft. Contact the factory for more information.
- >The AC power is fed to the EM-L/Sseries.

STEP 1: DISCONNECT AC POWER FROM FIXTURE

- >Disconnect all power sources from lighting fixture and ensure they are locked out during installation or maintenance.
- >Disconnect power leads from the AC driver.
- >Select a suitable location for the EM-L/Sseries and install such that its output leads can connect to the output leads of the AC driver.
- >See mounting method, for typical installation and select appropriate mounting method.

STEP 2: WIRING THE EM-L/S SERIES

- >Use the wiring diagram found as reference.
- >Connect the AC power source leads to the input of the EM-L/S series
- >Connect the output leads of the EM-L/Sseries to the LED module.
- >Wire the AC driver with the lamp in accordance with manufactures installation instructions.
- >Make sure all connections are in accordance with the National Electrical Code, and any local regulations.

>In a readily visible location, attach the label "CAUTION-This Unit Has More than one power connection point. To reduce the risk of electric shock, disconnect both the branch circuit-breakers or fuses and the EM-L/S series connector supply before servicing."

STEP 3: MOUNTING THE TEST ACCESSORIES

- >Gray wire and red wire of emergency backup into the switch box.
- >Connect same color the gray wire and red wire of indicator light, fix the panel switch to switch box.
- >The indicator light and test switch maybe mount into fixture. (Installation for J-box and indicator of the emergency with dual-flex wiring are as below : Install the indicator light to the opening hole and fix it and J-box onto the ceiling with the nut, then connect the wire according to the diagram before covering the J-box to finish.)

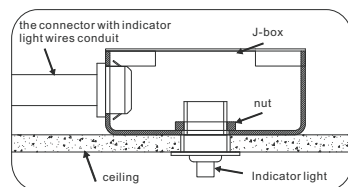
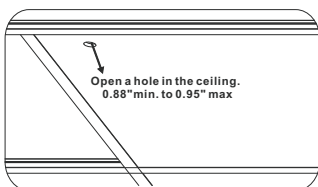

STEP 4: JOIN THE EM-L/S SERIES CONNECTOR & APPLY POWER

- >After installation is completed, join the EM-L/Sseries connector and apply AC power.
- >At this point, power should be connected to both the AC driver and the EM-L/S series and the Charging Indicator Light should illuminate indicating the battery is charging.
- >At short-term discharge test may be conducted after the EM-L/S series has been charging for 2 hours. Charge for 24 hours before conducting a longterm discharge test. Refer to operation.

OPERATION

During normal operation, AC power is supplied to the AC driver through the EM-L/S series and charges the battery. The EM-L/S series AC input line voltage (100-277AC) and automatically sets the output voltage during emergency mode.

When AC power fails, the EM-L/S series automatically switches to emergency mode, keeping the load illuminated for a minimum of 90 minutes. When AC power is restored, the EM-L/Sseries returns to charging mode. The EM-L/S series consists of a low-battery voltage disconnect which is reset when AC power is restored.

MAINTENANCE

Although no routine maintenance is required to keep the EM-L/S series functional, it should be checked periodically to ensure that it is working. The following schedule is recommended:

1. Visually inspect the charging indicator light monthly. It should be illuminated.
2. Test the emergency operation of the fixture at 30-day intervals for a minimum of 30 seconds. The lamp should operate at full illumination.
3. Conduct a 90-minute discharge test once a year. The lamp should operate at full illumination for at least 90 minutes.
4. When the red indicator flashes or off, the emergency power supply is abnormal.
5. If the emergency power supply is abnormal after the first installed, please charge for 2 hours and then check if it is normal.

WIRING DIAGRAM 1

(When the driver of the LED luminaires is over 70W)

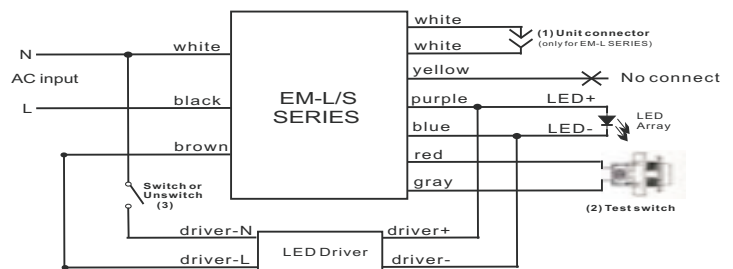

WIRING DIAGRAM 2

(When the driver of the LED luminaires is less than 70W)

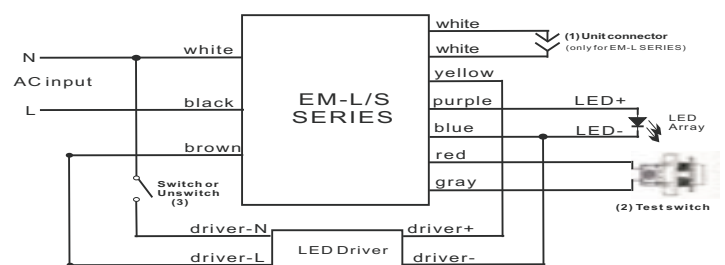

Note: Make sure the necessary branch circuit wiring is available. An unswitched source of power is required.